

■カラー鋼板(ロールフォーマーミング)

St120タイプ 120M型 働き巾120<sup>+0.8</sup>mm t=0.5  
(目地ありタイプ)

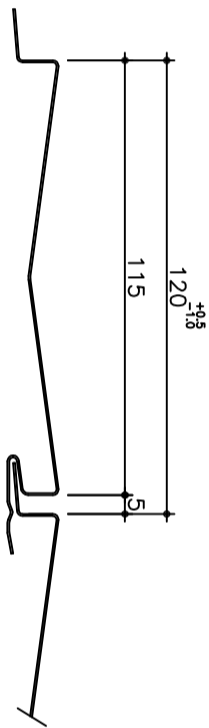

廻り縁 C-101 2m

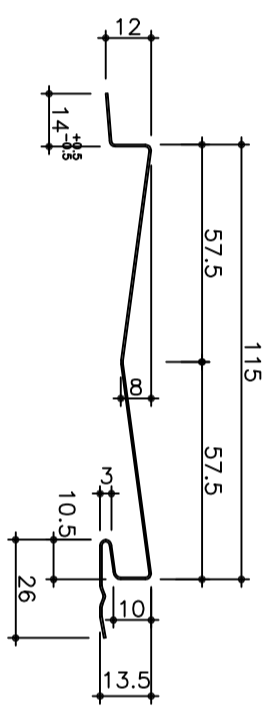
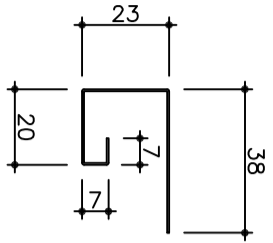

水切 C-202 2m

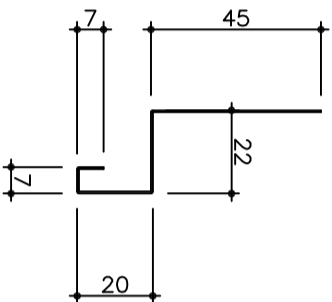

腰水切り C-250 2m

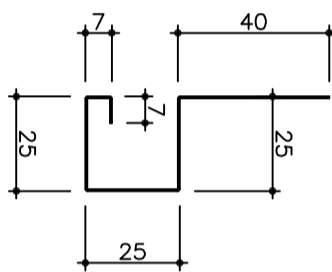

H型接続 C-400 2m

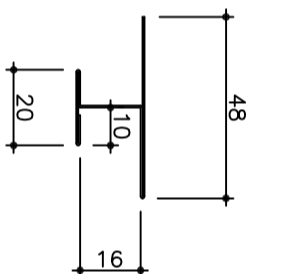

捨て板 C-5 2m

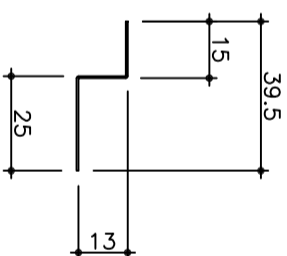

出隅 (C-303)  
(目地ありタイプ)

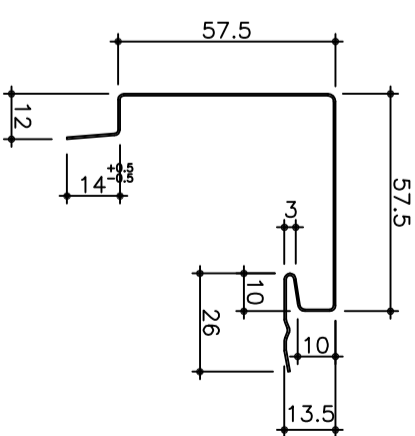

入隅 (C-304)  
(目地ありタイプ)

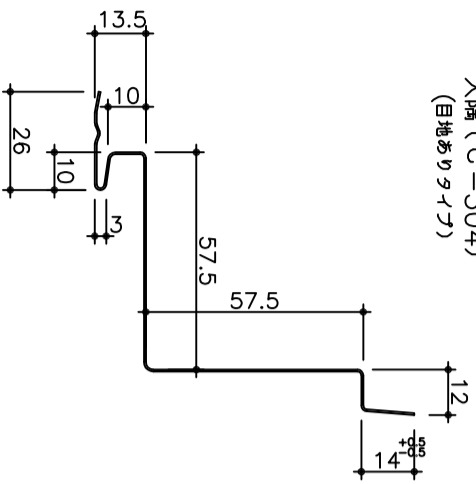

横張用出隅 (C-310) 2m

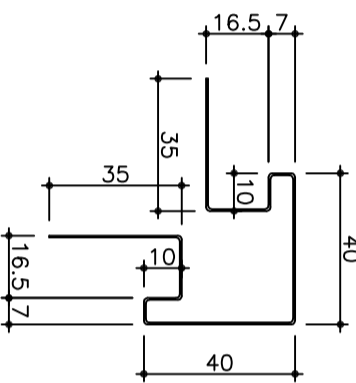

横張用入隅 (C-311) 2m

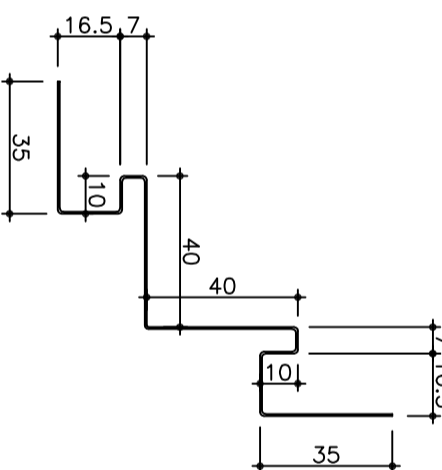

カラー鋼板F型スパン・付属品

St120タイプ

断面形状寸法図

Scale : 1/2



難波金属株式会社