

■カーステンレス(ロールフオーミング)

SUS K型タイラ 動き巾156⁺¹⁸ mm t=0.4

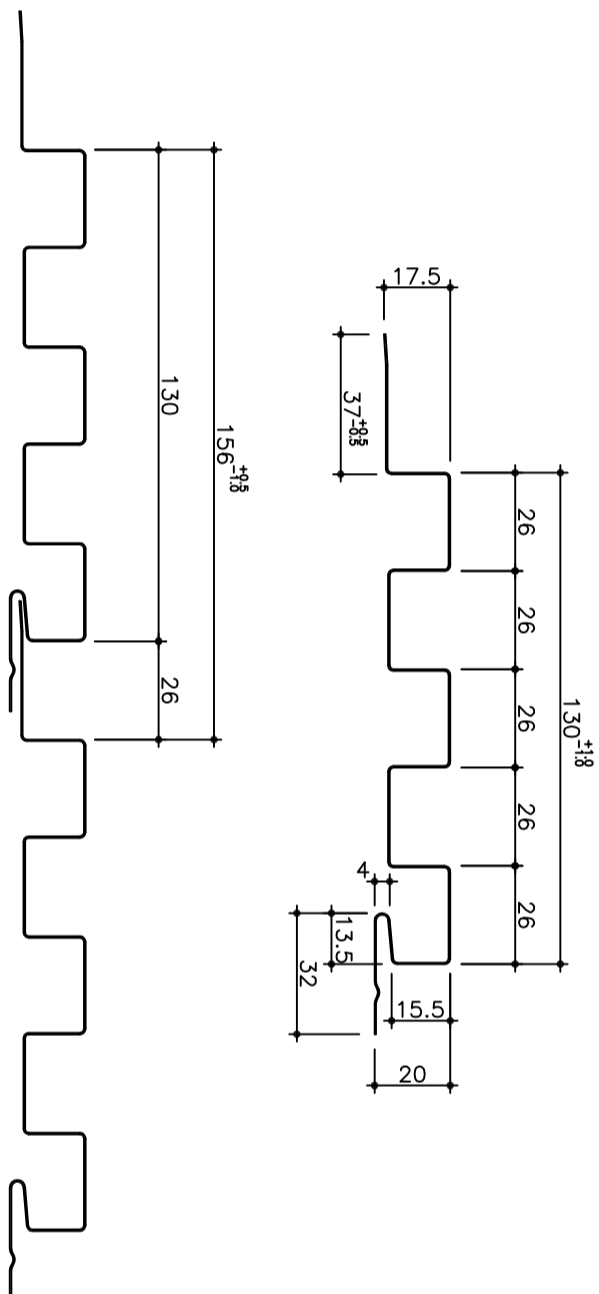

廻り縁 SK-101 2m (0.4t)

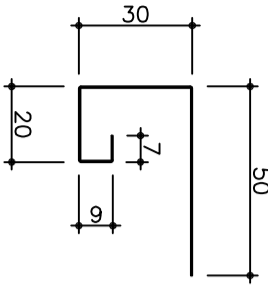

水切 SK-202 2m (0.4t)

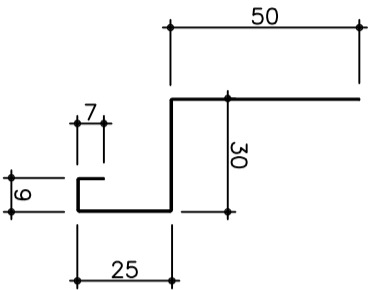

腰水切り C-250 2m (0.4t)

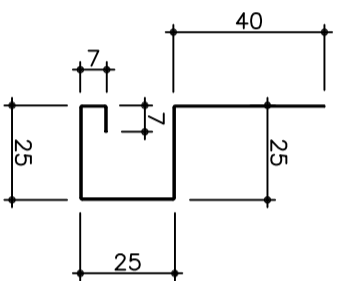

H型接続 SK-400 2m (0.4t)

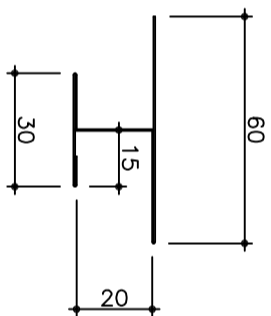

出隅 (SK-303) (0.4t)

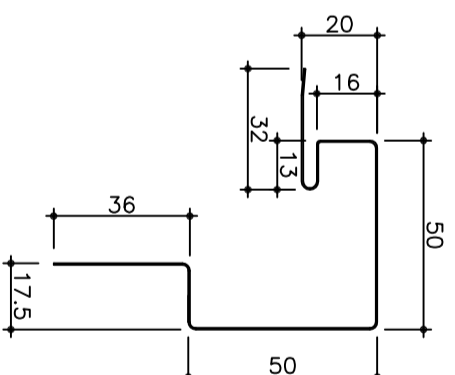

入隅 (SK-304) (0.4t)

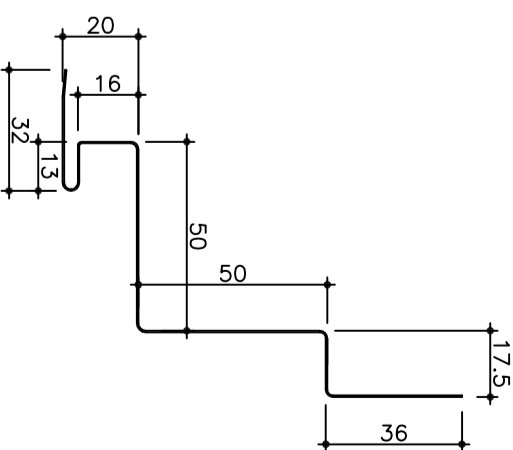

カーステンレスK型スパン・付属品

SUS K型タイラ

断面形状寸法図

Scale : 1/2